



Passport™ P4 AC Plus 4 Port AC/DC Multi-Charger



Instruction Manual

HORIZON®
H O B B Y

NOTICE

All instructions, warranties and other collateral documents are subject to change at the sole discretion of Horizon Hobby, LLC. For up-to-date product literature, visit horizonhobby.com or towerhobbies.com and click on the support or resources tab for this product.

MEANING OF SPECIAL LANGUAGE

The following terms are used throughout the product literature to indicate various levels of potential harm when operating this product:

WARNING: Procedures, which if not properly followed, create the probability of property damage, collateral damage, and serious injury OR create a high probability of superficial injury.

CAUTION: Procedures, which if not properly followed, create the probability of physical property damage AND possibility of serious injury.

NOTICE: Procedures, which if not properly followed, create a possibility of physical property damage AND little or no possibility of injury.



WARNING: Read the ENTIRE instruction manual to become familiar with the features of the product before operating. Failure to operate the product correctly can result in damage to the product, personal property and cause serious injury.

This is a sophisticated hobby product. It must be operated with caution and common sense and requires some basic mechanical ability. Failure to operate this Product in a safe and responsible manner could result in injury or damage to the product or other property. This product is not intended for use by children without direct adult supervision. Do not attempt disassembly, use with Incompatible components or augment product in any way without the approval of Horizon Hobby, LLC. This manual contains instructions for safety, operation and maintenance. It is essential to read and follow all the instructions and warnings in the manual, prior to assembly, setup or use, in order to operate correctly and avoid damage or serious injury.

Age Recommendation: Not for children under 14 years. This is not a toy.

NOTICE: This appliance is not intended for use by persons with reduced physical, sensory or mental capabilities, or lack of experience and knowledge, unless they have been given supervision or instruction concerning use of the appliance by a person responsible for their safety.



DANGER: To reduce the risk of fire or electric shock, carefully follow these instructions.



CAUTION: If at any time during the charge process the battery pack becomes hot or begins to puff, disconnect the battery immediately and discontinue the charge process as batteries can cause fire, collateral damage and injuries.



CAUTION: Using a charge rate that is not compatible with the battery capacity may result in damage or malfunction of the charger or battery.



CAUTION: The Lithium charge program menus are to be used ONLY for the charging and discharging of Lithium battery packs. Charging other battery types using the Lithium charge programs will damage the battery or the charger.

CHARGING WARNINGS



WARNING: Failure to exercise caution while using this product and comply with the following warnings could result in product malfunction, electrical issues, excessive heat, FIRE, and ultimately injury and property damage.

- **NEVER LEAVE CHARGING BATTERIES UNATTENDED DURING USE.**
- **NEVER CHARGE BATTERIES OVERNIGHT.**
- Never attempt to charge dead, damaged or wet battery packs.
- Never attempt to charge a battery pack containing different types of batteries.
- Never allow children under 14 years of age to charge battery packs.
- Never charge batteries in extremely hot or cold places or place in direct sunlight.
- Never charge a battery if the cable has been pinched or shorted.
- Never connect the charger if the power cable has been pinched or shorted.
- Never connect the charger to an automobile 12V battery while the vehicle is running.
- Never attempt to dismantle the charger or use a damaged charger.
- Never attach your charger to both an AC and a DC power source at the same time.
- Never connect the input jack (DC input) to AC power.
- Always use only rechargeable batteries designed for use with this type of charger in the correct programming mode.
- Always inspect the battery before charging.
- Always keep the battery away from any material that could be affected by heat.
- Always monitor the charging area and have a fire extinguisher available at all times.

- Always end the charging process if the battery becomes hot to the touch or starts to change form (swell) during the charge process.
- Always connect the charge cable to the charger first, then connect the battery to avoid short circuit between the charge leads. Reverse the sequence when disconnecting.
- Always connect the positive red leads (+) and negative black
- Always disconnect the battery after charging, and let the charger cool between charges.
- Always charge in a well-ventilated area.
- Always terminate all processes and contact Horizon Hobby if the product malfunctions.
- Charge only rechargeable batteries. Charging non-rechargeable batteries may cause the batteries to burst, resulting in injury to persons and/or damage to property.
- The socket-outlet shall be installed near the equipment and shall be easily accessible.



WARNING: Never leave charger unattended, exceed maximum charge rate, charge with non-approved batteries or charge batteries in the wrong mode. Failure to comply may result in excessive heat, fire and serious injury.



CAUTION: Always ensure the battery you are charging meets the specifications of this charger and that the charger settings are correct. Not doing so can result in excessive heat and other related product malfunctions, which can lead to user injury or property damage. Please contact Horizon Hobby or an authorized retailer with compatibility questions.

CONTENTS

Control Layout	4
Bluetooth Connection	6
Using The Mobile App.....	6
Charge Port Selection.....	6
Flow Chart.....	7
Getting Started	8
When Using An External Dc Power Source:.....	8
Dc Power Distribution	8
When Using An Ac Power Source:	8
Ac Power Distribution	8
Connecting Batteries To The Charger:.....	8
Operating Your Charger	9
Power Up Screen.....	9
Li** (Li-Po/Li-HV/Li-Fe/Li-Ion) Lithium Charging.....	9
Li** (Li-Po/Li-HV/Li-Fe/Li-Ion) Lithium Discharging	10
Li** (Li-Po/Li-HV/Li-Fe/Li-Ion) Lithium Storage Charging	10
Ni** (Ni-Mh/Ni-Cd) Charging.....	11
Ni** (Ni-Mh/Ni-Cd) Discharging.....	11
Ni** (Ni-Mh/Ni-Cd) Cycle Charging	12
Pb Charging	13
Pb Discharging.....	13
Battery Memory	14
Scan To Go.....	15
How To Generate A Qr Code:.....	15
How To Use A Qr Code:.....	15
System Settings	16
Troubleshooting	18
Charger Display.....	18
Solution.....	18
Warranty And Service Contact Information.....	19
Limited Warranty	19
Fcc Information	21

Specifications	
AC Power Distribution	Channels A and C: 100 watts total Channels B and D: 100 watts total
Power Distribution Adjustable Range	Channels A and B: 50 – 100 watts Channels C and D: 0 – 50 watts
Charge Current	Channels A and B: 0.1 – 10 Amps Channels C and D: 0.1 – 5 Amps
Peak Charge Voltage	LiPo: 4.18 – 4.20V/cell LiHV: 4.20 – 4.35V/cell LiFe: 3.58 – 3.6V/cell Lilon: 4.08 – 4.1V/cell NiMH/NiCd: Uses delta peak detection
Discharge Wattage	10 Watts per channel
Discharge Current	0.1 – 2 Amps per channel
Discharge Cut-off Voltages	LiPo: 3.0 – 3.3V/cell LiHV: 3.1 – 3.4V/cell LiFe: 2.6 – 2.9V/cell Lilon: 2.9 – 3.2V/cell NiMH/NiCd: 0.1 – 1.1V/cell
Input Voltage	100 – 240V AC (50 – 60Hz); 11 – 18V DC
Charging Capability	1 – 6S Li-Po/Li-HV/Li-Ion/Li-Fe; 1 – 15C Ni-Cd/Ni-MH; 2 – 12V Pb
Battery Capacities	100 – 50000 mAh
Charge Current	Channel A/B: 0.1A – 10A Channel C/D: 0.1-5A (in 0.1A Increments/100W max AC, 200W DC)
Discharge Current	0.10A – 5.0A x 4 (in 0.1A Increments/10W max)
Balance Current	200mA max per cell
Operating Temperature	0°C to + 40°C
Charging Mode	Ni-Cd/Ni-MH: Peak; 1-6S Li-Po/Li-HV/Li-Ion/Li-Fe/Pb: CC/CV
Protection	Short-circuit, over-current, reverse polarity, low input voltage, over-temperature

Included Items
AC Power Cord
(4) Charge Adapter: Banana to EC3™ Device (DYN0072)
(2) Bare charge leads
(4) Balancing Adapter Board: XH (DYN5032)

Optional Items
Temperature Sensor (DYN5033)
Dynamite® LiPo Charge Bag: small (DYN1400), large (DYN1405)
Charge Adapter: Banana to Deans (DYN0056)
Charge Adapter: Banana to XT60 (DYN0143)
DC Power Cord: Alligator to XT60 (DYN1108)

Standard Battery Parameters							
Battery Type	LiPo	Lilon	LiFe	LiHV	NiCd	NiMH	PB
Nominal Voltage (per cell)	3.7V	3.6V	3.3V	3.7V	1.2V	1.2V	2.0V
Max Charge Voltage (per cell)	4.2V	4.1V	3.6V	4.35V	1.5V	1.5V	2.4V
Storage Voltage (per cell)	3.8V	3.7V	3.3V	3.85V	n/a	n/a	n/a
Allowable Fast Charge Rate	≤1C	≤1C	≤4C	≤1C	≤1C	≤1C	≤0.4C
Minimum Discharge Voltage (per cell)	3.0V	2.9V	2.6V	3.1V	0.9V	0.9V	1.8V

CONTROL LAYOUT

- | | |
|--|--|
| A. DC Power Input Port | O. ENTER/Start |
| B. DC Power Cable (optional, not included) | P. Charge Port D Negative Power Output |
| C. Main Power Switch | Q. Charge Port D Positive Power Output |
| D. AC Power Input Cable | R. Charge Port D Balance Board Connector |
| E. AC Power Input Port | S. Charge Port D Temperature Sensor Port |
| F. LCD Screen | T. PC Link |
| G. Charge Port Selection Button | U. 5V 2.1A USB Power supply |
| H. Charge Port C Positive Power Output | V. Charge Port C Temperature Sensor Port |
| I. Charge Port C Negative Power Output | W. Battery Adapter Cable |
| J. Charge Port C Balance Connector | X. Charge Port A Negative Power Output |
| K. Balance Board | Y. Charge Port A Positive Power Output |
| L. BATT/PROG Stop | Z. Charge Port A Temperature Sensor Port |
| M. DEC (decrease) | AA. Charge Port A Balance Connector |
| N. INC (increase) | |

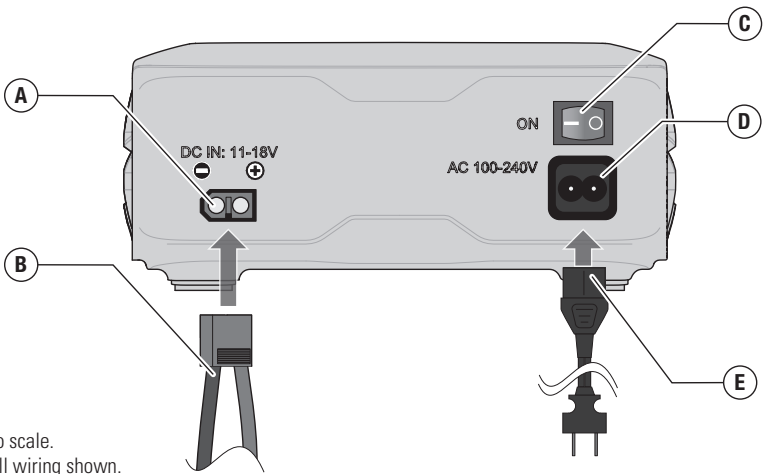

Not to scale.
 Not all wiring shown.
 Not all connectors shown.

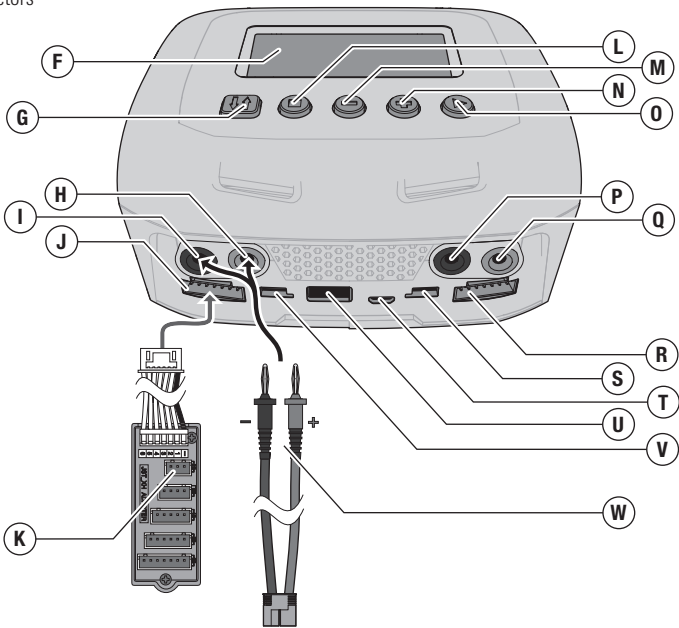

LEFT SIDE (PORT A)

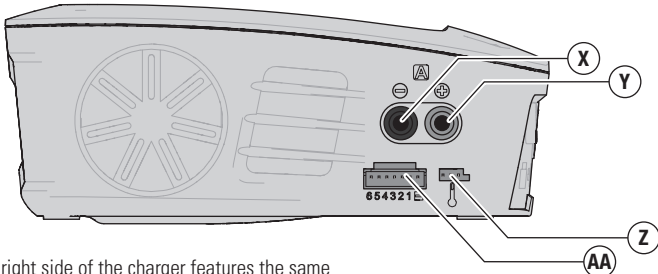

The right side of the charger features the same connections for port B as the left side has for port A.

BLUETOOTH CONNECTION

Scan the QR code at the right to download the Dynamite Dashboard App. All Charger features are accessible from the app.

Compatible with iOS and Android devices

1. Download the Dynamite Dashboard App from the iOS or Play Store.
2. Install the app and verify the Bluetooth is activated on the mobile device.
3. Power on the charger, and open the app. The app will open a dialog box that says Bluetooth Device, touch the line that says charger to connect. The Bluetooth Icon will illuminate on the charger when it is connected.
4. Set a password the first time the app is opened. We suggest writing the password on the back of the charger in permanent marker.

QR Code to download app



USING THE MOBILE APP

1. Touch and slide the selections to scroll between options.
2. Press the NEXT button when the correct selections have been made.

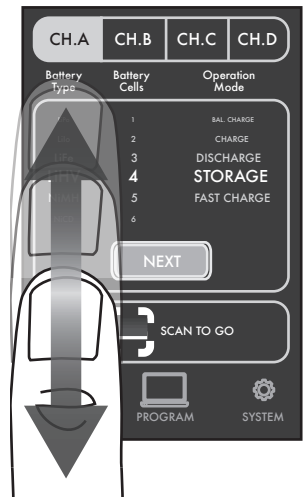

CHARGE PORT SELECTION

The Passport™ P4 charger has four charge ports. Press the **CHANNEL A/B/C/D** button to change between the charge ports. The selected charge port is highlighted with a black background.



FLOW CHART

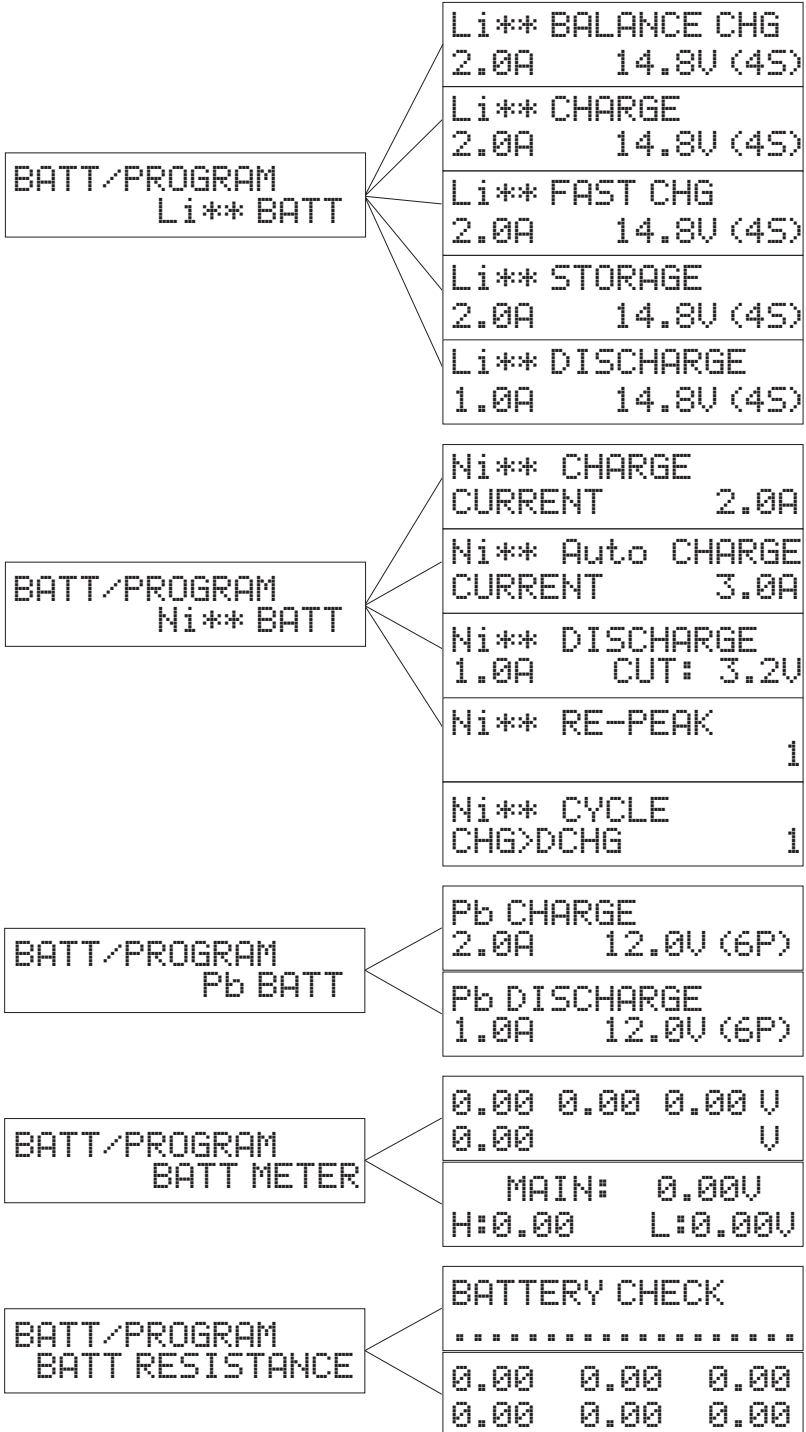

GETTING STARTED



CAUTION: Before charging, always ensure you have chosen the correct battery chemistry type for the battery you are charging.



CAUTION: Never connect the AC and DC input cords to an active power source at the same time. This will void the warranty, cause product damage and possibly injure the user.

WHEN USING AN EXTERNAL DC POWER SOURCE:

1. Connect the DC power cord to the charger DC Power Input Port.
2. Connect the DC power source.
3. When the charger is powered ON, a message will appear on the LCD Screen.



WARNING: Always connect cable polarities correctly.

NOTICE: Always consult 12V battery collateral materials or Horizon Hobby before using with sources other than a standard AC wall outlet.

DC POWER DISTRIBUTION

When powered from a DC power source, the P4 charger has a maximum charging output of 300 watts total power. 100 watts are allocated for channels A and B (each) and 50 watts per channel on channels C and D (each). Power Allocation is fixed when operating from a DC power supply. Select the chosen channel with the Port selection button.

WHEN USING AN AC POWER SOURCE:

1. Connect the AC power cord to the charger AC Power Input Port.
2. Connect the AC power cord to the AC power source.
3. When the charger is powered ON, a message will appear on the **LCD Screen**.

AC POWER DISTRIBUTION

When powered from an AC power source, the P4 charger has a maximum charging output of 200 watts total power. The power can be allocated as needed; allocations can be made in the AC Max Power Set screen.

4. Select the chosen channel with the Port selection button
 5. Press the BATT/PROG button to access the BATT/PROGRAM SYSTEM SETTINGS menu.
 6. Press ENTER/Start to enter the system settings menu, use the INC (increase) or DEC (decrease) buttons to select the AC Max Power Set screen. Press ENTER/Start and the wattage value will begin to flash.
 7. Use the INC (increase) or DEC (decrease) buttons to adjust the wattage for the selected channel (charge port). Making changes to one channel will adjust the available power on the corresponding linked channel. Channels A and C are linked and channels B and D are linked.
- Adjustment ranges for Channels A and B are 50 – 100 watts
 - Adjustment ranges for Channels C and D are 0 – 50 watts

CONNECTING BATTERIES TO THE CHARGER:



CAUTION: Always power ON the charger before connecting a battery, or damage to the charger and the battery can result.



CAUTION: For Pb (lead acid) batteries, Always connect/disconnect the battery before powering ON the charger, or damage to the charger and the battery can result.

1. Disconnect the battery charger from the AC or DC power source before connecting or disconnecting the battery.
2. Connect the charger to the power source
3. Select charge port (A,B,C, or D).
4. Select the charging settings.
5. Connect the banana plugs of the battery adapter cable to the Power Output of the selected charge port (A,B,C, or D), making sure that the positive and negative connectors are not reversed.
6. Connect the battery connector to the battery adapter cable, if charging LiPo or LiFe, connect the balance board as well.
7. Start battery charging.

OPERATING YOUR CHARGER

POWER UP SCREEN

When the charger is powered ON, there is a series of self tests and the charger will require the user to verify they have read the manual by pressing the **ENTER / Start** button. The charger will not proceed with charge functions until this process is completed.

**NEVER LEAVE THE CHARGER UNATTENDED WHILE IN OPERATION.
NEVER CHARGE ON OR AROUND COMBUSTIBLE MATERIALS.**



Charging batteries can be dangerous if proper precautions are not taken. By Pressing the ENTER button you are confirming that you understand this and that you have read the manual and understand the warnings enclosed.

WARNING!

LI** (LI-PO/LI-HV/LI-FE/LI-ION) LITHIUM CHARGING



CAUTION: Before charging or discharging, always ensure you have chosen the correct battery chemistry type for the battery you are charging.

1. Connect the banana plugs of the battery adapter cable to the charge port. Confirm the positive and negative connectors match, red to red (positive to positive) and black to black (negative to negative).
2. Connect the Balance Adapter Board to the Balance Port of the charge port.
3. Connect the battery connector to the battery adapter cable.
4. Connect the balance connector of the battery to the balance adapter.
5. Press the Batt / PROG Stop button to access the root menu. Press the DEC or INC button to scroll through the main menu screens until you reach Program Select=Li-Po/Li-Ion/Li-Fe.
6. Press ENTER / Start
7. Press the DEC or INC Button to scroll through the program options (Charge, Balance Charge, Storage, Discharge). Select Charge.
8. Press ENTER / Start to select a program option. The Parameter will begin flashing.
9. Press the DEC or INC Button to change the value of the parameter. Press the ENTER / Start Button again to move to the next parameter.
10. Once the parameters are at the desired settings, press and hold the ENTER / Start Button for 3 seconds. Press ENTER / Start again to confirm and start the charge process.
11. The charger will check the battery and charger settings and charging will begin.
12. Press the DEC Button to see the rest of the Charging information. Press the INC Button to see the voltages for each cell.
13. Press ENTER / Start to return to the charging screen.
14. Press the Batt / PROG Stop Button at any time to stop charging.
15. When charging is complete, the charger will sound a series of beeps.
16. Disconnect the battery from the charger when the charge is complete.

BATT/PROGRAM
Li** BATT

Li** CHARGE
2.0A 14.8V (4S)

4.20	4.20	4.20
0.00	0.00	0.00

Li** (LI-PO/LI-HV/LI-FE/LI-ION) LITHIUM DISCHARGING

1. Connect the banana plugs of the battery adapter cable to the charge port. Confirm the positive and negative connectors match, red to red (positive to positive) and black to black (negative to negative).
2. Connect the Balance Port to the Balance Circuit Adapter Board.
3. Connect the battery connector to the battery adapter cable.
4. Connect the balance connector of the battery to the Balance Adapter Board.
5. Press the **Batt / PROG Stop** button to access the root menu. Press the **DEC** or **INC** button to scroll through the main menu screens until you reach Program Select=Li-Po/Li-Ion/Li-Fe.
6. Press the **ENTER / Start** Button.
7. Press the **DEC** or **INC** Button until Li-Po/Li-Ion/Li-Fe DCHG appears.
8. Press the **ENTER / Start** Button to edit the parameter.
9. Once the parameters are at the desired settings, press and hold the **ENTER / Start** Button for 3 seconds. Press **ENTER / Start** again to confirm and start the discharge.
10. The charger will check the battery and charger settings and discharging will begin.
11. Press the **DEC** or **INC** Button to see the rest of the Discharging information.
12. Press **Batt / PROG Stop** at any time to stop discharging.
13. When discharging is complete, the charger will sound a series of beeps.
14. Disconnect the battery from the charger when the discharge is complete.

```
Li** DCHG 3.0V  
1.0A 9.0V(3S)
```

Li** (LI-PO/LI-HV/LI-FE/LI-ION) LITHIUM STORAGE CHARGING

1. Connect the banana plugs of the battery adapter cable to the charge port. Confirm the positive and negative connectors match, red to red (positive to positive) and black to black (negative to negative).
2. Connect the Balance Adapter Board to the Balance Port of the charge port.
3. Connect the battery connector to the battery adapter cable.
4. Connect the balance connector of the battery to the balance adapter.
5. Press the **Batt / PROG Stop** button to access the root menu. Press the **DEC** or **INC** button to scroll through the main menu screens until you reach Program Select=Li-Po/Li-Ion/Li-Fe.
6. Press the **ENTER / Start** Button.
7. Press the **DEC** or **INC** Button until Li-Po/Li-Ion/Li-Fe STORAGE appears.
8. Press the **ENTER / Start** Button to edit the parameter. The Parameter will begin flashing.
9. Press the **DEC** or **INC** Button to change the value of the parameter. Press the **ENTER / Start** Button again to move to the next parameter.
10. Once the parameters are at the desired settings, press and hold the **ENTER / Start** Button for 3 seconds. Press **ENTER / Start** again to confirm and start the process.
11. The charger will check the battery and charger settings and storage charging will begin.
12. Press the **DEC** or **INC** Button to see the rest of the storage charging information.
13. Press **Batt / PROG Stop** at any time to stop charging.
14. When the storage process is complete, the charger will sound a series of beeps.
15. Disconnect the battery from the charger when the storage process is complete.

```
Li** STORAGE  
2.0A 14.8V (4S)
```

NI** (NI-MH/NI-CD) CHARGING



CAUTION: Before charging or discharging, always ensure you have chosen the correct battery chemistry type for the battery you are charging.

1. Connect the banana plugs of the battery adapter cable to the charge port. Confirm the positive and negative connectors match, red to red (positive to positive) and black to black (negative to negative).
2. Connect the battery connector to the battery adapter cable.
3. Press the **Batt / PROG Stop** button to access the root menu. Press the **DEC** or **INC** button to scroll through the main menu screens until you reach Program Select=Ni-MH or Ni-Cd.
4. Press the **ENTER / Start** button.
5. Press the **DEC** or **INC** Button until Ni-MH/Ni-Cd CHARGE appears.
6. Press the **ENTER / Start** Button to edit the parameter. The Parameter will begin flashing.
7. Press the **DEC** or **INC** Button to change the value of the parameter. Press the **ENTER / Start** Button again to move to the next parameter.
8. Once the parameters are at the desired settings, press and hold the **ENTER / Start** button for 3 seconds.
9. The charger will check the battery and charger settings and charging will begin.
10. Press the **DEC** or **INC** Button to see the rest of the Discharging information.
11. Press **Batt / PROG Stop** at any time to stop discharging.
12. When charging is complete, the charger will sound a series of beeps.
13. Disconnect the battery from the charger when the charge is complete.

```
BATT/PROGRAM
Ni** BATT
```

```
Ni** CHARGE
CURRENT 2.0A
```

NI** (NI-MH/NI-CD) DISCHARGING

1. Connect the banana plugs of the battery adapter cable to the charge port. Confirm the positive and negative connectors match, red to red (positive to positive) and black to black (negative to negative).
2. Connect the battery connector to the battery adapter cable.
3. Press the **Batt / PROG Stop** button to access the root menu. Press the **DEC** or **INC** button to scroll through the main menu screens until you reach Program Select=Ni-MH/Ni-Cd.
4. Press the **ENTER / Start** button.
5. Press the **DEC** or **INC** Button until Ni-MH/Ni-Cd DISCHARGE appears.
6. Press the **ENTER / Start** Button to edit the parameter. The Parameter will begin flashing.
7. Press the **DEC** or **INC** Button to change the value of the parameter. Press the **ENTER / Start** Button again to move to the next parameter.
8. Once the parameters are at the desired settings, press and hold the **ENTER / Start** button for 3 seconds.
9. The charger will check the battery and charger settings and charging will begin.
10. Press the **DEC** or **INC** Button to see the rest of the Discharging information.
11. Press **Batt / PROG Stop** at any time to stop discharging.
12. When discharging is complete, the charger will sound a series of beeps.
13. Disconnect the battery from the charger when the discharge is complete.

```
Ni** DISCHARGE
1.0A CUT: 3.2V
```

NI** (NI-MH/NI-CD) CYCLE CHARGING

1. Connect the banana plugs of the battery adapter cable to the charge port. Confirm the positive and negative connectors match, red to red (positive to positive) and black to black (negative to negative).
2. Connect the battery connector to the battery adapter cable.
3. Press the **Batt / PROG Stop** button to access the root menu. Press the **DEC** or **INC** button to scroll through the main menu screens until you reach Program Select=Ni-MH/Ni-Cd.
4. Press the **ENTER / Start** button.
5. Press the **DEC** or **INC** button until Ni-MH/Ni-Cd CYCLE appears.
6. Press the **ENTER / Start** button to select the cycle direction. The direction may be changed with the lettering is flashing, press the **DEC** or **INC** button to change between CHG>DCHG or DCHG>CHG.
7. Press the **ENTER / Start** Button to define the number of cycles. When the number flashes number of cycles can be set with the **DEC** or **INC** button. Current settings for charge and discharge rates will be applied for Ni** cycling
8. Once the parameters are set, press and hold the **ENTER / Start** button for 3 seconds.
9. The charger will check the battery and charger settings and charging will begin.
10. Press the **DEC** or **INC** Button to see the rest of the Cycle information.
11. Press **Batt / PROG Stop** at any time to stop discharging.
12. When cycling is complete, the charger will sound a series of beeps.
13. Disconnect the battery from the charger when the cycle is complete.

Ni** CYCLE	
CHG>DCHG	1



CAUTION: Before charging, always ensure you have chosen the correct battery chemistry type for the battery you are charging.



CAUTION: For Pb (lead acid) batteries, Always connect/disconnect the battery before powering ON the charger, or damage to the charger and the battery can result.



WARNING: Explosive gases. Prevent flames and sparks. Provide adequate ventilation during charging.

PB CHARGING

1. Connect the banana plugs of the battery adapter cable to the charge port. Confirm the positive and negative connectors match, red to red (positive to positive) and black to black (negative to negative).
2. Connect the battery connector to the battery adapter cable.
3. Press the **Batt / PROG Stop** button to access the root menu. Press the **DEC** or **INC** button to scroll through the main menu screens until you reach Program Select=Pb BATT.
4. Press the **ENTER / Start** button.
5. Press the **DEC** or **INC** Button until Pb CHARGE appears.
6. Press the **ENTER / Start** Button to edit the parameter. The Parameter will begin flashing.
7. Press the **DEC** or **INC** Button to change the value of the parameter. Press the **ENTER / Start** Button again to move to the next parameter.
8. Once the parameters are at the desired settings, press and hold the **ENTER / Start** button for 3 seconds.
9. The charger will check the battery and charger settings and charging will begin.
10. Press the **DEC** or **INC** Button to see the rest of the charging information.
11. Press **Batt / PROG Stop** at any time to stop discharging.
12. When charging is complete, the charger will sound a series of beeps.
13. Disconnect the battery from the charger when the charge is complete.

```
BATT/PROGRAM
Pb BATT
```

```
Pb CHARGE
2.0A 12.0V (6P)
```

PB DISCHARGING

1. Connect the banana plugs of the battery adapter cable to the charge port. Confirm the positive and negative connectors match, red to red (positive to positive) and black to black (negative to negative).
2. Connect the battery connector to the battery adapter cable.
3. Press the **Batt / PROG Stop** button to access the root menu. Press the **DEC** or **INC** button to scroll through the main menu screens until you reach Program Select=Pb BATT.
4. Press the **ENTER / Start** button.
5. Press the **DEC** or **INC** Button until Pb DISCHARGE appears.
6. Press the **ENTER / Start** Button to edit the parameter. The Parameter will begin flashing.
7. Press the **DEC** or **INC** Button to change the value of the parameter. Press the **ENTER / Start** Button again to move to the next parameter.
8. Once the parameters are at the desired settings, press and hold the **ENTER / Start** button for 3 seconds.
9. The charger will check the battery and charger settings and discharging will begin.
10. Press the **DEC** or **INC** Button to see the rest of the Discharging information.
11. Press **Batt / PROG Stop** at any time to stop discharging.
12. When discharging is complete, the charger will sound a series of beeps.
13. Disconnect the battery from the charger when the discharge is complete.

```
Pb DISCHARGE
1.0A 12.0V (6P)
```

BATTERY MEMORY

The charger can store up to 10 settings for specific batteries.

The following images show programming a Li** battery, options will vary with Ni** and Pb battery types.

1. Press the Batt / PROG Stop button to access the root menu. Press the DEC or INC button to scroll through the main menu screens until you reach BATT/PROGRAM BATT MEMORY.
2. Press the ENTER / Start button to enter the Battery Memory settings
3. Press the DEC or INC button to select the battery memory (1-10) you wish to configure.
4. Press the ENTER / Start button to go to the first page of settings for the selected battery memory.
5. Press the ENTER / Start button to edit the parameter.
6. Press the DEC or INC button to increase or decrease the value of each page. When the value is flashing it can be adjusted with the increase or decrease buttons.



WARNING: TVC sets the maximum voltage allowed for each cell in lithium charge modes. We recommend leaving the TVC value at 4.2V. Only raise the voltage above 4.2V when charging LiHV batteries.

7. Press the **ENTER / Start** button again to save the selection. When all the values on the page are solid and do not flash, pressing the increase or decrease buttons will move to the next value in the battery memory.
8. Complete the menu options for the battery memory, and press the **ENTER / Start** on the Save Program page to save the battery memory. The changes to the battery memory will not be saved if this option is not selected.
9. Press the **Batt / PROG Stop** button to return to the main menu.
10. To select a battery memory, access the BATT/PROGRAM BATT MEMORY screen, select the memory number desired and press the **ENTER / Start** button to start the charge.
11. Re-load the factory settings in the SYSTEM SETTINGS menu to reset the battery memory slots.

```
[ BATT MEMORY X ]  
ENTER SET->
```

```
BATT TYPE  
LiPo
```

```
BATT VOLTAGE  
14.8V(4S)
```

```
CHARGE CURRENT  
2.0A
```

```
DISCHRG CURRENT  
1.0A
```

```
DISCHG VOLTAGE  
3.0V/CELL
```

```
TVC=YOUR RISK!  
4.20V
```

```
SAVE PROGRAM  
ENTER
```

SCAN TO GO

The Passport P4 can be automatically set with the SCAN TO GO feature by scanning a compatible QR code. Check your battery for a compatible QR code. If you need to add one, a QR code can be generated from within the Battery Memory section.

HOW TO GENERATE A QR CODE:

1. Add battery memory settings to match your battery.
2. Touch the QR code next to the battery memory, save it to the Gallery on your device.
3. Print the QR code and apply it to your battery.

Example settings shown, the app does not include any pre-configured memory settings.



HOW TO USE A QR CODE:

1. Touch the SCAN TO GO button from the HOME screen in the Dynamite Dashboard App.
2. The camera will open on your device, use this to scan the QR code.
3. When the QR code is scanned it will apply the parameters, press START to begin charging.

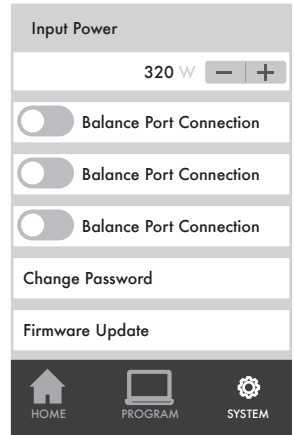

SYSTEM SETTINGS

```
BATT/PROGRAM
SYSTEM SETTING->
```

1. Press the **Batt / PROG Stop** button to access the root menu. Press the **DEC** or **INC** button to scroll through the main menu screens until you reach BATT/PROGRAM SYSTEM SETTING page.
2. Press the **ENTER / Start** button to enter the system setting menu.
3. Press the **DEC** or **INC** button to scroll through the menu.
4. Press the **ENTER / Start** button to edit the parameter.
5. Press the **DEC** or **INC** button to increase or decrease the value.
6. Press the **ENTER / Start** button again to save the selection.
7. Press the **Batt / PROG Stop** button to return to the main menu.

SAFETY TIMER DEFAULT IS ON, 120MIN

```
Safety Timer
ON 120Min
```

Use the Safety Timer menu to set a time limit for charging a battery. When a charge cycle is started, a clock inside the charger will begin recording the elapsed charge time. If the safety timer function has been turned ON, the charger will stop the charging process once this time limit has been reached to avoid damage caused by overcharging the battery. This time value can be set between 10 and 720 minutes, in 1 minute Increments.

CAPACITY CUT-OFF DEFAULT IS ON, 5000MAH

```
Capacity Cut-Off
ON 5000MAH
```

Use the Capacity Cut-Off menu to set a capacity limit on when the charger stops charging a battery. When a charge cycle starts, the charger records the battery capacity. When the capacity cutoff function is set at ON, the charger will stop charging at the capacity limit to prevent battery damage. Capacity can be adjusted between 10 and 50,000mAh in 100mAh Increments.

TEMP. CUT-OFF DEFAULT IS 50C/122F

```
Temp Cut-Off
On 50C 122F
```

The charger can be used in conjunction with a battery mounted temperature sensor (sold separately, DYN5033) connected to the Temperature Sensor Port to monitor the temperature of the battery during the charging process. If the battery temperature reaches the cut-off limit, the charger will stop the charging process. Temperature values can be adjusted between 20–80° C (68–176° F).

```
Temperature Unit
Celcius
```

The following screen sets the charger for Celcius or Fahrenheit.

REST TIME FOR CYCLE– DEFAULT IS 10 MINUTES

```
Rest Time
CHG>DCHG 10Min
```

Sets the delay during a Charge/Discharge cycle, after the charge completes, before the discharge begins.

NI-MH SENSITIVITY D. PEAK – DEFAULT

```
NiMH Sensitivity
D.Peak 4mV
```

The D.Peak (Delta Peak) value is adjustable between 3mV/Cell and 15mV/Cell. 8mV/Cell is a good starting point for Ni-MH batteries. If the Delta Peak value is too high, you risk overcharging the battery; if the value is too low, charging will stop before the battery reaches full capacity.

NI-CD SENSITIVITY D. PEAK – DEFAULT

The D.Peak (Delta Peak) value is adjustable between 3mV/Cell and 15mV/Cell. 10mV/Cell is a good starting point for Ni-Cd batteries. If the Delta Peak value is too high, you risk overcharging the battery; if the value is too low, charging will stop before the battery reaches full capacity.

```
NiCd Sensitivity
D.Peak          4mV
```

KEY BEEP (DEFAULT ON) / BUZZER (DEFAULT ON)

Use the Key Beep/Buzzer menu to set the key beep and charger alarm buzzer at ON or OFF as needed. We recommend that you leave the alarm ON to alert you when charging is complete or if there is cause for alarm during charging.

```
Key Beep       ON
Buzzer         ON
```

DC INPUT LOW

Defines the minimum voltage the charger will operate at when using a DC power supply.

```
DC INPUT LOW
              10.00
```

BALANCE CONNECTION (DEFAULT ON)

When the Balance connection is on the charger will require a balance connection for Li-XX batteries and will confirm the batteries are within safe limits or the charger will not start the charge process.

```
Bal. Connection
              ON
```

AC MAX POWER

Prset this value to limit the AC power draw, which can be helpful for powering from a generator or inverter.

```
AC MAX POWER
              100W
```

LOAD FACTORY SETTINGS PRESS ENTER > 2S

Press the **ENTER / Start** button for more than 2 seconds to reset all charger values to the default values.

```
Load Factory Set
              Enter
```

HARDWARE AND FIRMWARE SETTINGS

Select this option to view the Hardware and Firmware version numbers

```
VERSION
HW:      FW:
```

TROUBLESHOOTING

During charger operation, circuits monitor battery and charger functions. If the following messages show on the charger's LCD screen, make the recommended responses. If the message continues after you respond as recommended, contact your nearest Horizon Hobby customer service center for assistance.

CHARGER DISPLAY	SOLUTION
REVERSE POLARITY	Confirm polarity is correct between the charger and the battery
NO BATT DETECTED	The battery connection has been broken
CONNECT ERROR CHECK MAIN PORT	The battery connection is incorrect
BALANCE CONNECT ERROR	The balance connection is incorrect
DC IN TOO LOW	The DC power supply voltage is below the 11 volt minimum
DC IN TOO HIGH	The DC power supply voltage is above the 18 volt limit
CELL ERROR LOW VOLTAGE	The voltage of one or more cell(s) in the battery pack is too low
CELL ERROR HIGH VOLTAGE	The voltage of one or more cell(s) in the battery pack is too high
CELL ERROR VOLTAGE-INVALID	The voltage of one or more cell(s) in the battery pack is invalid
CELL NUMBER INCORRECT	The number of cells the charger is set for does not match the battery
INT. TEMP. TOO HI	The internal temperature of the charger is too high
EXT. TEMP. TOO HI	The external temperature of the battery is too high (the optional temp probe DYN5033 is required to test external temperature)
OVER CHARGE CAPACITY LIMIT	The charger has stopped charging because it reached the capacity limit set by the user
OVER TIME LIMIT	The charger has stopped charging because it reached the charge time limit
BATTERY WAS FULL	The battery voltage is higher than the maximum voltage set by the user when the charge is initiated

WARRANTY AND SERVICE CONTACT INFORMATION

Country of Purchase	Horizon Hobby	Contact Information	Address
United States of America	Horizon Service Center (Repairs and Repair Requests)	servicecenter.horizonhobby.com/RequestForm/	2904 Research Rd Champaign, Illinois, 61822 USA
	Horizon Product Support (Product Technical Assistance)	productsupport@horizonhobby.com.	
		877-504-0233	
	Sales	websales@horizonhobby.com	
800-338-4639			

LIMITED WARRANTY

What this Warranty Covers - Horizon Hobby, LLC, (Horizon) warrants to the original purchaser that the product purchased (the "Product") will be free from defects in materials and workmanship for a period of 1 year from the date of purchase.

What is Not Covered - This warranty is not transferable and does not cover (i) cosmetic damage, (ii) damage due to acts of God, accident, misuse, abuse, negligence, commercial use, or due to improper use, installation, operation or maintenance, (iii) modification of or to any part of the Product, (iv) attempted service by anyone other than a Horizon Hobby authorized service center, (v) Product not purchased from an authorized Horizon dealer, (vi) Product not compliant with applicable technical regulations, or (vii) use that violates any applicable laws, rules, or regulations.

OTHER THAN THE EXPRESS WARRANTY ABOVE, HORIZON MAKES NO OTHER WARRANTY OR REPRESENTATION, AND HEREBY DISCLAIMS ANY AND ALL IMPLIED WARRANTIES, INCLUDING, WITHOUT LIMITATION, THE IMPLIED WARRANTIES OF NON-INFRINGEMENT, MERCHANTABILITY AND FITNESS FOR A PARTICULAR PURPOSE. THE PURCHASER ACKNOWLEDGES THAT THEY ALONE HAVE DETERMINED THAT THE PRODUCT WILL SUITABLY MEET THE REQUIREMENTS OF THE PURCHASER'S INTENDED USE.

Purchaser's Remedy - Horizon's sole obligation and purchaser's sole and exclusive remedy shall be that Horizon will, at its option, either (i) service, or (ii) replace, any Product determined by Horizon to be defective. Horizon reserves the right to inspect any and all Product(s) involved in a warranty claim. Service or replacement decisions are at the sole discretion of Horizon. Proof of purchase is required for all warranty claims. SERVICE OR REPLACEMENT AS PROVIDED UNDER THIS WARRANTY IS THE PURCHASER'S SOLE AND EXCLUSIVE REMEDY.

Limitation of Liability - HORIZON SHALL NOT BE LIABLE FOR SPECIAL, INDIRECT, INCIDENTAL OR CONSEQUENTIAL DAMAGES, LOSS OF PROFITS OR PRODUCTION OR COMMERCIAL LOSS IN ANY WAY, REGARDLESS OF WHETHER SUCH CLAIM IS BASED IN CONTRACT, WARRANTY, TORT, NEGLIGENCE, STRICT LIABILITY OR ANY OTHER THEORY OF LIABILITY, EVEN IF HORIZON HAS BEEN ADVISED OF THE POSSIBILITY OF SUCH DAMAGES. Further, in no event shall the liability of Horizon exceed the individual price of the Product on which liability is asserted. As Horizon has no control over use, setup, final assembly, modification or misuse, no liability shall be assumed nor accepted for any resulting damage or injury. By the act of use, setup or assembly, the user accepts all resulting liability. If you as the purchaser or user are not prepared to accept the liability associated with the use of the Product, purchaser is advised to return the Product immediately in new and unused condition to the place of purchase.

Law - These terms are governed by Illinois law (without regard to conflict of law principals). This warranty gives you specific legal rights, and you may also have other rights which vary from state to state. Horizon reserves the right to change or modify this warranty at any time without notice.

WARRANTY SERVICES

Questions, Assistance, and Services - Your local hobby store and/or place of purchase cannot provide warranty support or service. Once assembly, setup or use of the Product has been started, you must contact your local distributor or Horizon directly. This will enable Horizon to better answer your questions and service you in the event that you may need any assistance. For questions or assistance, please visit our website at horizonhobby.com, submit an inquiry to productsupport@horizonhobby.com or call the toll-free telephone number referenced in the Warranty and Service Contact Information section to speak with a Product Support representative.

Inspection or Services - If this Product needs to be inspected or serviced and is compliant in the country you live and use the Product in, please use the Horizon Online Service Request submission process found on our website or call Horizon to obtain a Return Merchandise Authorization (RMA) number. Pack the Product securely using a shipping carton. Please note that original boxes may be included, but are not designed to withstand the rigors of shipping without additional protection. Ship via a carrier that provides tracking and insurance for lost or damaged parcels, as Horizon is not responsible for merchandise until it arrives and is accepted at our facility. An Online Service Request is available at http://www.horizonhobby.com/content/service-center_render-service-center. If you do not have internet access, please contact Horizon Product Support to obtain a RMA number along with instructions for submitting your product for service. When calling Horizon, you will be asked to provide your complete name, street address, email address and phone number where you can be reached during business hours. When sending product into Horizon, please include your RMA number, a list of the included items, and a brief summary of the problem. A copy of your original sales receipt must be included for warranty consideration. Be sure your name, address, and RMA number are clearly written on the outside of the shipping carton.

Provided warranty conditions have been met, your Product will be serviced or replaced free of charge. Service or replacement decisions are at the sole discretion of Horizon.

NOTICE: Do not ship LiPo batteries to Horizon. If you have any issue with a LiPo battery, please contact the appropriate Horizon Product Support office. Warranty Requirements - For Warranty consideration, you must include your original sales receipt verifying the proof-of-purchase date.

Non-Warranty Service -

Should your service not be covered by warranty, service will be completed and payment will be required without notification or estimate of the expense unless the expense exceeds 50% of the retail purchase cost. By submitting the item for service you are agreeing to payment of the service without notification. Service estimates are available upon request. You must include this request with your item submitted for service. Non-warranty service estimates will be billed a minimum of ½ hour of labor. In addition you will be billed for return freight. Horizon accepts money orders and cashier's checks, as well as Visa, MasterCard, American Express, and Discover cards. By submitting any item to Horizon for service, you are agreeing to Horizon's Terms and Conditions found on our website http://www.horizonhobby.com/content/service-center_render-service-center.

ATTENTION: Horizon service is limited to Product compliant in the country of use and ownership. If received, a non-compliant Product will not be serviced. Further, the sender will be responsible for arranging return shipment of the un-serviced Product, through a carrier of the sender's choice and at the sender's expense. Horizon will hold non-compliant Product for a period of 60 days from notification, after which it will be discarded.

10/15

FCC INFORMATION

FCC ID: REY-Q200

FCC Information

This device complies with part 15 of the FCC rules. Operation is subject to the following two conditions: (1) This device may not cause harmful interference, and (2) this device must accept any interference received, including interference that may cause undesired operation.



CAUTION: Changes or modifications not expressly approved by the party responsible for compliance could void the user's authority to operate the equipment.

This product contains a radio transmitter with wireless technology which has been tested and found to be compliant with the applicable regulations governing a radio transmitter in the 2.400GHz to 2.4835GHz frequency range.

Supplier's Declaration of Conformity

Dynamite Passport™ P4 AC Plus 4 Port AC/DC Multi-Charger

DYNC3018



This device complies with part 15 of the FCC Rules. Operation is subject to the following two conditions: (1) This device may not cause harmful interference, and (2) this device must accept any interference received, including interference that may cause undesired operation.



CAUTION: Changes or modifications not expressly approved by the party responsible for compliance could void the user's authority to operate the equipment.

NOTE: This equipment has been tested and found to comply with the limits for a Class B digital device, pursuant to part 15 of the FCC Rules. These limits are designed to provide reasonable protection against harmful interference in a residential installation. This equipment generates, uses and can radiate radio frequency energy and, if not installed and used in accordance with the instructions, may cause harmful interference to radio communications. However, there is no guarantee that interference will not occur in a particular installation. If this equipment does cause harmful interference to radio or television reception, which can be determined by turning the equipment off and on, the user is encouraged to try to correct the interference by one or more of the following measures:

- Reorient or relocate the receiving antenna.
- Increase the separation between the equipment and receiver.
- Connect the equipment into an outlet on a circuit different from that to which the receiver is connected.
- Consult the dealer or an experienced radio/TV technician for help.

Horizon Hobby, LLC

2904 Research Rd.,

Champaign, IL 61822

Email: compliance@horizonhobby.com

Web: HorizonHobby.com

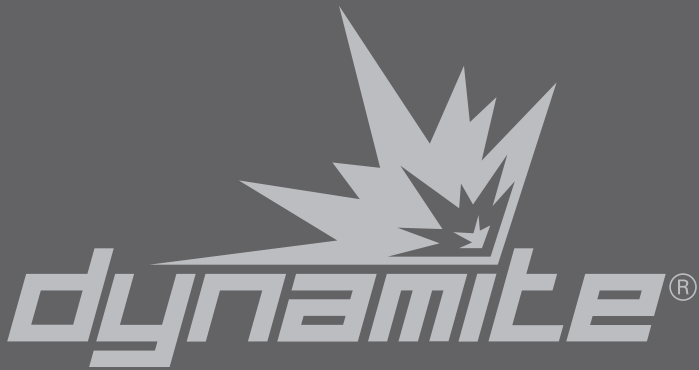

© 2020 Horizon Hobby, LLC. Dynamite, Passport, EC3 and the Horizon Hobby Logo are trademarks or registered trademarks of Horizon Hobby, LLC. All other trademarks, service marks and logos are property of their respective owners.
58521.3 Created 07/2020